

# effimer!

CATALOGUE 2021



VAJILLA DESECHABLE & BIODEGRADABLE  
DISPOSABLE & BIODEGRADABLE TABLEWARE  
VAISSELLE JETABLES & BIODÉGRADABLES



#effimer #packagingmakers #effimerstyle #foodporn  
#welovepackaging #catering #patatasbravas #foodlover  
#foodstyling #ecofriendly #lovefood #foodblogger  
#gourmet #streetfood #chef #chefs #instafood #foodie  
#burgerlovers #streetstyle #foodies #yummi #foodpics  
#delicious #delish #foodforfoodie #tasty #hungry  
#italianfood #ecofriendly #foodlovers #winelovers  
#asianfood #foodtruck #effimer #packagingmakers  
#effimerstyle #welovepackaging #foodporn #catering  
#patatasbravas #foodlover #foodstyling #ecofriendly  
#lovefood #foodblogger #gourmet #streetfood #chef  
#chefs #instafood #burgerlovers #streetstyle #foodie  
#foodies #foodpics #delicious #delish #foodforfoodie  
#tasty #hungry #italianfood #ecofriendly #yummi  
#foodlovers #winelovers #foodporn #catering  
#patatasbravas #foodlover #foodstyling #ecofriendly  
#lovefood #foodblogger #gourmet #street food #chef  
#chefs #instafood #burgerlovers #streetstyle #foodie  
#foodies #yummi #foodpics #delicious #delish #tas-  
ty #foodforfoodie #hungry #italianfood #foodlovers  
#winelovers #asianfood #foodtruck



Effimer



@effimer\_com



Effimer\_com



## NOSOTROS

Effimer es una empresa consolidada con más de 40 años de experiencia en el sector del packaging y de los productos desechables. Nos basamos en esta experiencia para detectar rápidamente las necesidades del mercado y así ofrecer a nuestros clientes los productos más innovadores y originales, sin olvidar su funcionalidad ni el compromiso con las normas de calidad. En Effimer fabricamos nuestros productos en base a la calidad y el servicio y también estamos a su disposición para la creación y producción personalizada y a medida de los productos que puedan necesitar. Destacamos también la presencia de un equipo humano muy cercano y siempre a su disposición que intenta comunicar todo de manera amable sencilla, precisa y personalizada.

## ABOUT US

*Effimer is an owned family company with more than 40 years of experience in the packaging and the disposable ware industry.*

*Based on our know-how we identify instantly the needs of the market in order to offer the most innovative and brand new products focusing on its functionality as well as the quality requirements.*

*We produce our products according to our quality and the client-oriented principles. We are at your disposal for any specific need that requires a tailor-made solution for your best product exhibition.*

*As a result you will get a wide range of products and a notable charming staff that you'll always feel beside you, always at your disposal with high communication skills-profile with a customised, precise and clear message.*

## A PROPOS DE NOUS

**Effimer est une société familiale de grande consolidation avec une expérience de plus de 40 ans dans le marché de l'emballage et des produits à usage unique. Notre expérience est la base pour identifier en tout moment les besoins du marché et offrir à nos clients les produits les plus originaux et novateurs, sans oublier sa fonctionnalité ni le compromis avec les standards de qualité.**

**Effimer fabrique les produits sur la base de la qualité et le service; nous sommes à votre disposition pour développer et construire sur mesure les produits dont vous en avez besoin.**

**Comme résultat, nous vous proposons une vaste gamme de produits à votre choix, en mettent l'accent sur sa équipe humaine qui reste toujours très proche de vous, à votre disponibilité et qui essayera de vous communiquer tout message d'une manière précise, simple et personnalisée.**

2021

Después de dos años donde el packaging para alimentación, especialmente el de plástico, ha estado en boca de todos tanto en los medios de comunicación como en las comisiones de la Unión Europea, con algunas afirmaciones poco rigurosas desde nuestro punto de vista y otras bastante acertadas. Sacamos una clara conclusión: hemos de cuidar nuestro planeta de una manera responsable desde todos los ámbitos.

Desde Effimer nos hemos propuesto eliminar cualquier tipo de artículo que sea no reciclable o no reutilizable. En este catálogo casi todos nuestros artículos cumplen los requisitos de los parámetros requeridos por la comisión de expertos de la UE (ley IP/18/3927). Todos los nuevos artículos incluidos en este catálogo son Ecológicos.

2021

*After two years where plastic food packaging found itself as a hot topic in the media and in the European Union Commissions, there were some statements that lacked certain rigour from our point of view, and others more on the mark. From that we've drawn a clear conclusion: we must all take care of our planet responsibly in every way possible.*

*We here at Effimer therefore propose to eliminate any type of non-recyclable or non-reusable items. In this catalog almost all our articles meet the requirements of the parameters required by the EU commission of experts (law IP / 18/3927). All new items included in this catalog are Ecological.*

2021

Après deux ans où les emballages destinés aux denrées alimentaires, en particulier le plastique, les médias et les commissions de l'Union européenne en ont beaucoup discuté avec des déclarations peu rigoureuses de notre point de vue et d'autres assez réussies. Nous arrivons à une conclusion claire: nous devons prendre soin de notre planète de manière responsable dans tous les domaines.

Dans Effimer, nous avons proposé d'éliminer tout type d'article non recyclable ou réutilisable. Dans ce catalogue, presque tous nos articles répondent aux exigences des paramètres requis par la commission d'experts de l'UE (loi IP / 18/3927). Tous les nouveaux articles inclus dans ce catalogue sont écologiques.

## SERVICIOS EFFIMER

Transporte y entrega: Según la destinación.

Entrega dentro de un plazo entre 24-72 horas dentro de la Península

Solicitud de muestras:

Si tenéis interés en recibir muestras hacéndonos saber por email o por teléfono junto con los datos de vuestra empresa y vuestra dirección con una relación de los productos con los que estáis interesados

Cómo hacer el pedido:

Por email a la dirección:

[info@effimer.com](mailto:info@effimer.com)

A través de nuestra página de compra online orientada al pequeño comercio

[www.effimer.com](http://www.effimer.com)

Por teléfono:

+34 972216049

Primer pedido:

Para el primer pedido, necesitaremos una persona de contacto, teléfono, la razón social de la empresa, el CIF, la dirección de facturación y la de envío y posibles detalles horarios, fechas de entrega concretas,....

Modalidades de pago:

Por transferencia, pagaré o giro bancario a 30 días

Personalización de productos:

Nuestros productos Y el packaging pueden ser personalizados (logo-tipo, tamaños, cantidades, colores.....) en función de las cantidades solicitadas

## EFFIMER SERVICES

*Delivery Terms :*

*According to the destination.*

*Delivery between 24-72 hours within the peninsula*

*Sampling :*

*If you need to have samples please let us know by mail or phone along with your Company details, address and the reference of items required.*

*Orders:*

*Please forward all orders to your Agent or:*

*[info@effimer.com](mailto:info@effimer.com).*

*Through the online purchase page, oriented to small business:*

*[www.effimer.com](http://www.effimer.com)*

*By phone:*

*+34 972216049*

*First Order:*

*For the first order we would need the contact details family name, company name, VAT number, Invoicing and delivery addresses, specific delivery days and times, etc.*

*Payment terms:*

*transfer, promissory note or bank draft to 30 days*

*Customizing:*

*Our products and packaging can be customized (logo brand, size, quantities...) depending on the volume required.*

## EFFIMER SERVICES

**Elivraisons:**

**Selon la destination.**

**Livraisons en 48 heure au sein de la péninsule**

**Echantillonnage :**

**Dans le cas où vous désirez recevoir échantillons, veuillez nous faire parvenir un mail avec vos coordonnées (nom de la société, adresse et les références souhaitées.**

**Commandes**

**Par courriel de votre Agent Commercial ou: [info@effimer.com](mailto:info@effimer.com)**

**À travers nos achats en ligne axés sur les petites entreprises**

**[www.effimer.com](http://www.effimer.com)**

**Par téléphone:**

**+34 972216049**

**Première Commande :**

**Merci de nous communiquer votre nom, la dénomination sociale, le SIRET/SIREN, adresses de livraison et siège social, horaires et jours de livraison, etc.**

**Règlement :**

**transfert, billet à ordre ou virement bancaire à 30 jours**

**Personnalisation:**

**Les produits et l'emballage peuvent être personnalisés (votre logo, mesures, quantités, couleurs...) selon le volume souhaité delivery addresses, specific delivery days and times, etc**

## Simbología / Symbology / Symbologie



APTO PARA LAVAPLATOS  
DISHWASHER SUITABLE  
ADAPTÉ AUX LAVE-VAISSELLE



HORNEABLE  
SUITABLE FOR OVEN  
BRÛLE



APTO PARA MICROONDAS  
MICROWAVE SUITABLE  
ADAPTÉ AUX MICRO-  
ONDES



CONGELABLE  
FREEZABLE  
CONGELÉ



Más tamaños bajo pedido mín.  
More sizes on mín. request  
Plus de tailles sur mín.  
demande



BIODEGRADABLE



RECICLABLE  
RECYCLABLE



PERSONALIZABLE. PEDIDO MÍN.  
CUSTOMIZABLE MIN. ORDER  
PERSONNALISABLE PAR ORDRE MIN.



CASH AND CARRY



Producto disponible en España, Portugal y Norte de África  
Product available in Spain, Portugal and North Africa  
Produit disponible en Espagne, au Portugal et en Afrique du Nord



TAPA ANTIVAHU BAJO PEDIDO  
ANTI MIST LID COVERED ANTIVAHU UNDER ORDER  
ANTIVAHU COUVERT SUR COMMANDE

Las fotografías que aparecen en el catálogo no son contractuales  
Non-contractual photographs on the catalog  
Les photographies figurant dans le catalogue ne sont pas contractuelles





**Cartón:** Fabricado a través de celulosa o fibra de maderas. Es un material reciclable. Soporta líquidos calientes. / **Cardboard:** Manufactured through cellulose or wood fiber. It is a recyclable material. Withstands hot liquids. / **Carton:** Fabriqué en cellulose ou en fibre de bois. C'est un matériau recyclable. Résiste aux liquides chauds

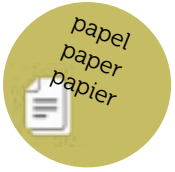

**Papel:** A base de fibra de madera proveniente de bosques sostenibles y gestionados responsablemente. Con un crecimiento neto mayor que lo que se cosecha anualmente. Reciclable y compostable. / **Paper:** Made from wood fiber from sustainable forests and managed responsibly. With a higher net growth than what is harvested annually. Recyclable and compostable. / **Papier:** Faites de fibres de bois provenant de forêts durables et gérées de manière responsable. Avec une croissance nette supérieure à celle récoltée annuellement. Recyclable et compostable



**Caña de azúcar:** Obtenida a través de los residuos sobrantes de la producción de azúcar. Es un material compostable y biodegradable. / **Sugarcane:** Obtained through the waste left over from sugar production. It is a compostable and biodegradable material. / **Canne à sucre:** obtenue à partir des déchets de la production de sucre. C'est un matériau compostable et biodégradable



**Hoja de palma:** Obtenidos a través de hojas de palmera caídas de forma natural. Es un material biodegradable. / **Palm leaf:** Obtained through palm leaves fallen naturally. It is a biodegradable material. / **Feuille de palmier:** obtenue à travers des feuilles de palmier tombées naturellement. C'est un matériau biodégradable



**Plástico reciclado y reciclable rPET:** Fabricado a través de productos PET ya utilizados. Puede seguir siendo reciclado. / **Recycled and recyclable plastic rPET:** Manufactured through PET products already used. It can still be recycled. / **rPET en plastique recyclé et recyclable:** fabriqué à partir de produits en PET déjà utilisés. Il peut encore être recyclé.



**Madera:** Material completamente natural con lo que estos envases son compostables, biodegradables y reciclables. Nuestra madera cuenta con los certificados pertinentes PEFC y FSC. / **Wood:** Completely natural material with which these containers are compostable, biodegradable and recyclable. Our wood has the relevant certificates PEFC and FSC. / **Bois:** Matériau entièrement naturel avec lequel ces conteneurs sont compostables, biodégradables et recyclables. Notre bois possède les certificats pertinents PEFC et FSC



**PLA:** Termoplástico obtenido a través del almidón de maíz, la yuca o la caña de azúcar es un material biodegradable y fácilmente degradable. / **PLA:** Thermoplastic obtained through corn starch, cassava or sugar cane, it is a biodegradable and easily degradable material. / **PLA:** Thermoplastique obtenu à travers l'amidon de maïs, le manioc ou la canne à sucre, c'est un matériau biodégradable et facilement dégradable.



**Bambú:** El bambú es un material 100% biodegradable, necesita poca agua y crece muy rápido. / **Bamboo:** Bamboo is a 100% biodegradable material, needs little water and grows very fast. / **Bambou:** Le bambou est un matériau 100% biodégradable, nécessite peu d'eau et pousse très vite.



**Salvado de trigo:** Obtenido a través de un proceso muy limpio que necesita poca agua y recursos minerales. Compostable en 30 días. / **Wheat bran:** It requires a very clean process that needs very little water and mineral resources. Compostable in 30 days. / **Son de blé:** Cela nécessite un processus très propre qui nécessite très peu de ressources en eau et en minéraux.

# 2020 NEWS



*Windows Box  
Pag. 18-19*



*Super Recycled  
Tray Pag. 16-18*



*Bandeja cartón  
compartimentos  
Pag. 20-21*

*Vasos y copas / glasses &  
cups verres et coupes PLA  
Pag. 44-45*



*Containers kraft  
Pag. 24-25*



*Cubiertos/ cutlery/ cou-  
verts Pag. 81*



*Cocktail ECO  
Pag. 34-35*

*Vasos/ glasses/ verres kraft  
Pag. 26-27*



# Index

Street Food & Take Away  
*Pag. 10-31*

Green Cocktail  
*Pag. 32-45*

Madera/ Wood/ Bois  
*Pag. 46-59*

Bandejas/ Trays/ / Plateaux  
*Pag. 60-67*

Platos/ Plates/ Assiettes  
*Pag. 68-77*

Cubiertos & Accesorios/ Cutlery & Accesories/ Couverts & Accessoires  
*Pag. 78-85*

Cocktail  
*Pag. 86-97*

# Street Food & Take Away





# Street food & take away

Be Sushi!



Min  
50000u.



**BE SUSHI!**



Personalízalas  
Customize  
Personalise



Gama de bandejas de cartón con medidas especiales para presentar sushi (y por supuesto, lo que tu imaginación te sugiera). Todos los tamaños son apilables y disponen de su tapa rPET para transportar todo el sabor japonés a cualquier evento con todo su frescor.

Range of cardboard trays with special measures to present sushi (and of course what your imagination suggests). All sizes are stackable and have their rPET lid to transport all the Japanese flavor to any event with all its freshness.

Gamme de plateaux en carton avec mesures spéciales pour présenter les sushis (et bien sûr ce que votre imagination suggère). Toutes les tailles sont empilables et ont leur couvercle en rPET pour transporter toute la saveur japonaise à n'importe quel événement avec toute sa fraîcheur.



Be Sushi!



Min 50000u.



**PERFECT TO DELIVERY & TAKE AWAY**

1235



1233

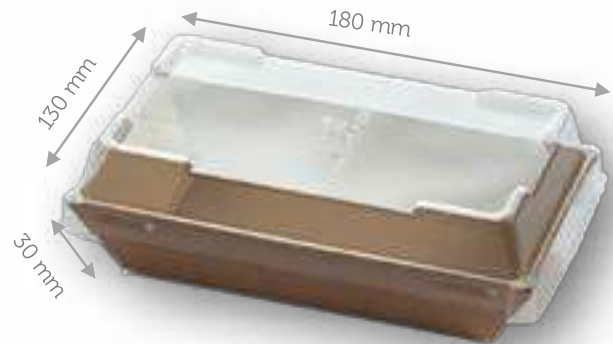

1234

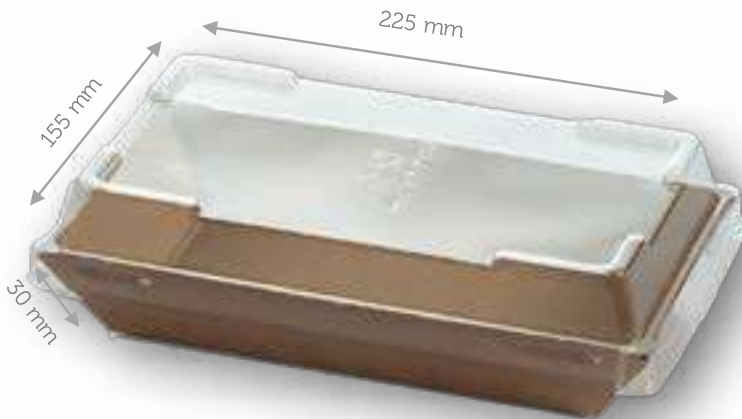

TAPA ANTIVAHO BAJO PEDIDO  
ANTI MIST LID COVERED UNDER ORDER  
ANTIVAHO COUVERT SUR COMMANDE

Se recomienda etiqueta adhesiva para evitar posible apertura de la tapa/ Adhesive label is recommended to avoid possible lid opening/ Une étiquette adhésive est recommandée pour éviter une éventuelle ouverture du couvercle

Ref.	Descripción / description	mm	Uds. Caja/Uts. case/ Qte. colis	Precio/Price/ Prix €/U	Tapa/ lid/ Cou- vercle
1233	Be Sushi	180x130x30	600	0.217	1233/T
1234		225x155x30	600	0.27	1234/T
1235		145x80x30	1620	0.186	1235/T
1239		210x90x30	330	0.25	1239/T

# Street food & take away

Be Salad!



Min  
50000u.

*Be Salad*



Mantén la frescura por dentro y por fuera en tus ensaladas (o del plato que desees) con la colección Be Salad. Todas con tapa rPET disponible y con opción antivhao bajo pedido

Keep the freshness inside and out in your salads (or the dish you want) with the Be Salad collection. All with rPET lid available and anti mist option under order.

Gardez la fraîcheur à l'intérieur et à l'extérieur de vos salades (ou du plat de votre choix) avec la collection Be Salad. Toutes avec plafond de rPET disponible et option Antivhao sur commande



ALTURA DE TODAS LAS TAPAS  
ALL LIDS HEIGHT  
HAUTEUR DE TOUS LES COUVERCLES  
28mm



Ref.	mm	MI	Uds. Caja/Uts. case/ Qte. colis	Precio/Price/ Prix €/U	Tapa/ lid/ Couvercle	
1238/A	130x130x60	550	800	0,2	1238/T	

SE RECOMIENDA ETIQUETA ADHESIVA PARA EVITAR POSIBLE APERTURA DE LA TAPA/  
ADHESIVE LABEL IS RECOMMENDED TO AVOID POSSIBLE LID OPENING/  
UNE ÉTIQUETTE ADHÉSIVE EST RECOMMANDÉE POUR ÉVITER UNE ÉVENTUELLE OUVERTURE DU COUVERCLE



# Street food & take away



Super Recycle tray



Min  
50000u.



Sistema de cierre patentado  
*Patented closure system*  
Système de fermeture breveté



Super Recycle tray es la nueva colección de bandejas de cartón con tapa de cartón con ventana de acetato de celulosa y un práctico sistema de cierre con un perfecto acabado que permite trasladar las bandejas sin miedo a derramar su contenido.

*Super Recycle tray is the new collection of cardboard trays with cardboard lid with cellulose acetate window and a practical closure system with a perfect finish that allows the trays to be moved without fear of spilling their contents.*

Le Super Recycle tray est la nouvelle collection de plateaux en carton avec couvercle en carton avec fenêtre en acétate de cellulose et un système de fermeture pratique avec une finition parfaite qui permet de déplacer les plateaux sans craindre de renverser leur contenu.

# Street food & take away

## Super Recycle tray



Min  
50000u.



*ideal para menús!*  
*Ideal for menus!*  
**Idéal pour les menus!**



*ideal para emplatar!*  
*Ideal for plating!*  
**Idéal pour le placage**



## Super Recycle tray



Min  
50000u.



2 tipos de tapas disponibles/ 2 lids available/ 2 couvercles disponibles



Cartón/ Cardboard/ carton  
+ Acetato de celulosa/ cellulose  
acetate/ **acétate de cellulose**



rPET

TAPA ANTIVAHU BAJO PEDIDO  
ANTI MIST LID COVERED UNDER ORDER  
ANTIVAHU COUVERT SUR COMMANDE

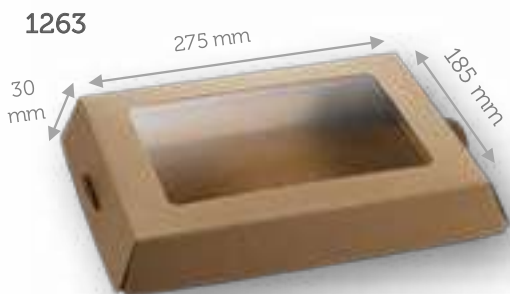

1263



1264



1265

Ref.	Descripción /description	mm	Uds. Caja/Uts. case/ Qte. colis	Precio/Price/ Prix €/U	Tapa/ lid/ Cou- vercle	
1263	Super Recycle tray	275x185x30	180	0,50	1263/TC	
1264		317x240x30	100	0,69	1264/TC	
1265		370x270x30	100	0,82	1265/TC	

# Street food & take away

## Windows Box



Ref.	Descripción / description	cm	Packs	Uds. Caja/Uts. case/ Qte. colis	
1638/A		13X13X6	10 packs x 25 uts	250	
1633/A		18X13X5	10 packs x 25 uts	225	
1634/A		22X15X5	10 packs x 25 uts	250	



1638/A



1633/A



1634/A



# Street food & take away

Bandeja compartimentos / Compartment tray/  
Plateau de compartiment



PERFECT TO  
DELIVERY &  
TAKE AWAY

1252



Ref.	Descripción /description	mm	Packs	Uds. Caja/Uts. case/ Qte. colis	
1252	Bandeja compartimentos / Compartment tray/ Plateau de compartiment	500x300x70	Por determinar/to be determined/ A déterminer		

Bols disponibles pag. 36-37  
Bowls available on page 36-37  
Bols disponibles sur la page 36-37

**NEW**



Personalízalas  
Customize  
Personnalise



Bandejas interiores pag. 20-21  
Interior trays on page 20-21  
Plateaux intérieurs sur la page 20-21

# Street food & take away

Recipientes /containers/ Conteneurs



Min  
50000u.

PERFECT TO  
DELIVERY &  
TAKE AWAY

1010512

1100 ml.



1010510

500 ml.



2035

750 ml.



Ref.	Descripción /description	ml	Packs	Uds. Caja/Uts. case/ Qte. colis	
1010510	Ensaladera cartón kraft/ Kraft cardboard salad bowl/ Saladier en carton kraft	500	25 packs x 10 uts.	250	
2035		750	-	300	
2035/T	Tapa Ensaladera cartón kraft/ lid Kraft cardboard sa- lad bowl/ couvercle Saladier en carton kraft			200	
1010512	Ensaladera cartón kraft	1100	25 packs x 10 uts.	250	





**PERFECT TO  
DELIVERY &  
TAKE AWAY**



Ref.	Descripción /description	ml	Packs	Uds. Caja/Uts. case/ Qte. colis	
2030	Sopera cartón kraft/ bowl soup kraft/ bol à soupe kraft	500	10 packs x 25 uts.	250	
1010513	Recipiente cartón kraft/ kraft container/ récipient en carton kraft	26 oz/ 780	16 packs x 25 uts	400	
1010514		45 oz/ 1350	16 packs x 25 uts	400	
1010515		60 oz/ 1980	16 packs x 25 uts	400	
1010552	Envase cartón kraft Noodles/ Kraft Noodles container/ récipient en carton kraft	16 oz/ 480		250	
1010553		26 oz/ 780		500	

# Street food & take away

## Bowls Bio



ZE14967



ZE14970



Con tapa PLA  
With PLA lid  
Avec couvercle PLA

Ref.	Descripción /description	mm	ml	Uds. Caja/Uts. case/ Qte. colis	
ZE14966	Bol cuadrado/ square bowl/ Bol carré	170x170x40	500	500	
ZE14967		170x170x55	750	500	
ZE15258	Tapa/ lid/ couvercle	-	-	500	
ZE14970	Bol redondo/ round bowl/ bol ronde	ø210x45	600	500	
ZE13343	Tapa/ lid/ couvercle	-	-	240	



PERFECT TO DELIVERY & TAKE AWAY



1231

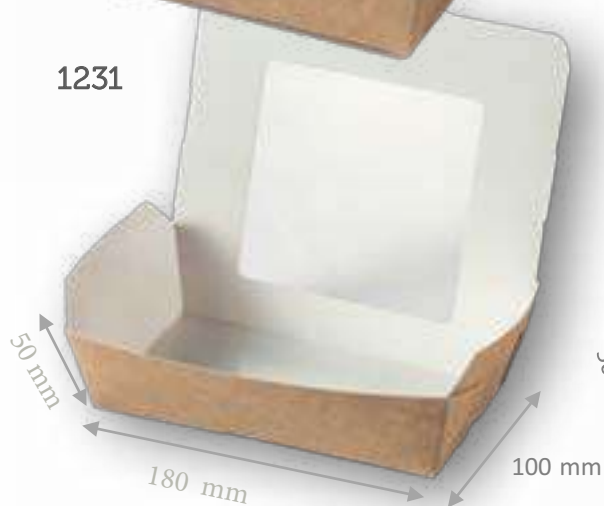

1230

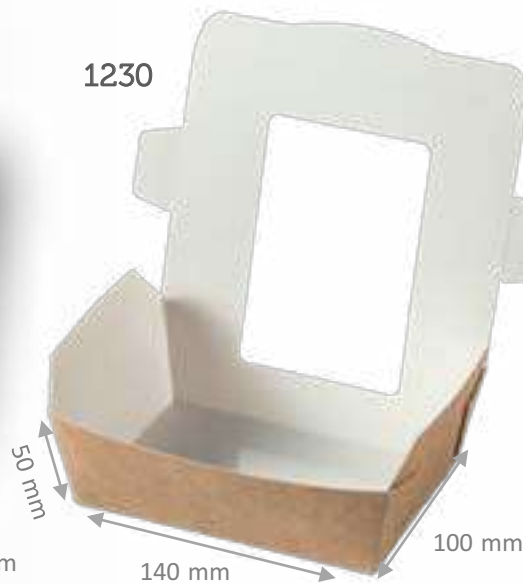

Ref.	Descripción /description	mm	Packs	Uds. Caja/Uts. case/ Qte. colis	
1230	Global Box	140x100x50	3 packs x 100 uts	300	
1231		180x100x50	2 packs x 150 uts	300	

# Street food & take away

Vasos/ Glasses/ verres kraft



Min  
50000u.

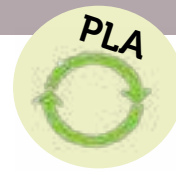

1



A



2



3 tipos de vasos/ 3 types of cups 3 tipos de gobelets:  
1 kraft  
2 kraft corrugado/ corrugated/ ondulé  
3 laminado capa PLA/ laminated PLA layer/  
couche de PLA laminé

2 tipos de tapa/ 2 lid styles/ 2 styles de couverture  
A PS  
B PLA

B



3



Bio



Ref.	Descripción /description	ml	Packs	Uds. Caja/Uts. case/ Qte. colis	
1010302	Vaso cartón kraft/ kraft cardboard cup/ tasse en carton kraft	4 oz / 120	20 packs x 50 uts	1000	
1010303		6 oz / 180	20 packs x 50 uts	1000	
1010304		8 oz / 240	20 packs x 50 uts	1000	
1010305		12 oz / 360	20 packs x 50 uts	1000	
1010306		16 oz / 480	20 packs x 50 uts	1000	
1010307		Vaso cartón kraft corrugado/ Corrugated kraft cardboard cup/ Gobelet en carton kraft ondulé	4 oz / 120	20 packs x 50 uts	1000
1010308	8 oz / 240		25 packs x 20 uts	500	
1010309	12 oz / 360		25 packs x 20 uts	500	
1010310	16 oz / 480		25 packs x 20 uts	500	
1010348	Vaso cartón kraft laminado PLA/ PLA laminated kraft cardboard cup/Gobelet en carton kraft laminé PLA	4 oz / 120	10 packs x 100 uts	1000	
1010349		6 oz / 180	10 packs x 100 uts	1000	
1010350		8 oz / 240	10 packs x 100 uts	1000	
1010351		12 oz / 360	10 packs x 100 uts	1000	
1010352		16 oz / 480	10 packs x 100 uts	1000	
1010311	Tapa PS/ Lid PS/ couvercle PS	4 oz	50 packs x 20 uts	1000	
1010312		6 oz	50 packs x 20 uts	1000	
1010313		8 oz	50 packs x 20 uts	1000	
1010315		12 & 16 oz	50 packs x 20 uts	1000	
1010436	Tapa PLA/ Lid PLA/ couvercle PLA	6 oz	50 packs x 20 uts	1000	
1010437		8 oz	50 packs x 20 uts	1000	
1010438		12 & 16 oz	50 packs x 20 uts	1000	

# Street food & take away

## Newsfood



Min  
50000u.



Papel antigrasa  
Greaseproof paper  
Papier sulfurisé



1220



1221

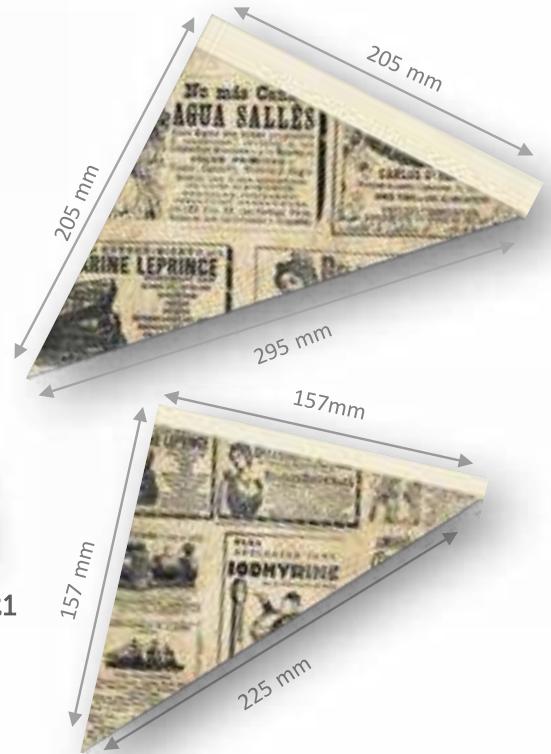

1222

Ref.	Descripción / description	mm	Packs	Uds. Caja/Uts. case/ Qte. colis	
1220	Newsfood	420x305	2packs x 1000 uts.	2000	
1221		157x157x225	25 packs x 80 uts.	2000	
1222		205x205x295	16 packs x 100 uts.	1600	

Papel antigrasa  
Greaseproof paper  
Papier sulfurisé

Newsfood



Min  
50000u.



PERFECT TO  
DELIVERY &  
TAKE AWAY

VINTAGE

Ref.	Descripción / description	mm	Packs	Uds. Caja/Uts. case/ Qte. colis
1480/P	Newsfood	243x152	10 packs x 500 uts	5000
1481/P		303x244	2 packs x 1000 uts	2000
1482/P		328x278	2 packs x 1000 uts	2000

# Street food & take away

## Food truck Bio Trays



Min  
50000u.



Rellena con hamburguesa y patatas, con nachos, ensaladas.. cualquier cosa queda bien en nuestras Food truck Bio trays!

Stuffed with hamburger and potatoes, with nachos, salads, anything looks good in our Food truck Bio trays!

Farcis avec hamburger et pommes de terre, avec nachos, salades, tout est beau dans notre camion Bio Trays Food!



Ref.	Descripción / description	mm	Packs	Uds. Caja/Uts. case/ Qte. colis	
1216	Food Truck Bio tray	Top: 130x100x40 Bottom: 85x50x40	10 packs x 100 uts	1000	
1217		Top: 150x125x40 Bottom: 110x75x40	10 packs x 100 uts	1000	
1218		Top: 240x160x50 Bottom: 170x95x50	-	1260	



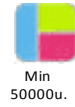

1216

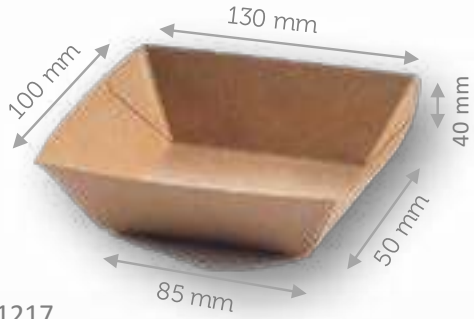

1217

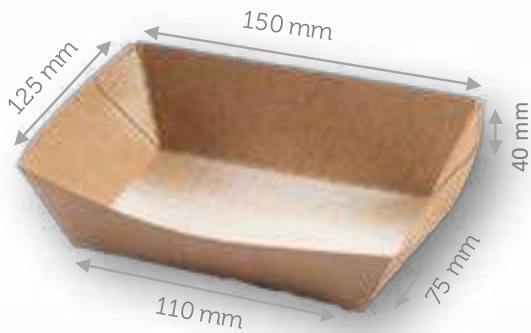

1218

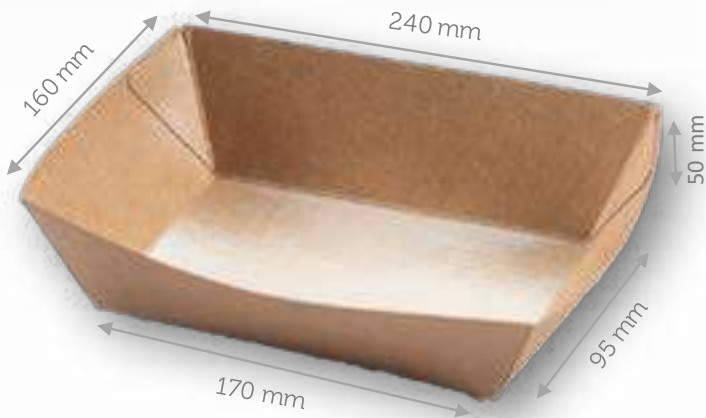

# Green Cocktail





# Green Cocktail

"JuJu" collection



Bio



Ref.	Descripción /description	mm	Packs	Uds. Caja/Uts. case/ Qte. colis	
1310	koopa "juju"	65/32x45	12 packs x 50 uts	600	
1311	koopa "juju"	85/42x65	12 packs x 30 uts	360	
1310/T	Tapa koopa "juju"		24 packs x 50 uts	1200	
1311/T	Tapa koopa "juju"		24 packs x 30 uts	720	



Presenta tus platos y degustaciones de la manera más elegante y ecofriendly  
*Present your dishes and tastings in the most elegant and ecofriendly way*  
Présentez vos plats et dégustations de la manière la plus élégante et la plus écologique



Con tapa de PLA  
*With PLA lid*  
Avec couvercle en PLA



Soporta líquidos y temperatura  
*Supports liquids and temperature*  
Supporte les liquides et la température

# Green Cocktail

Miniaturas/ Miniatures Bio



Bio



15354



15355



15356



15357



10763



N465



Ref.	Descripción /description	mm	Uds. Caja/ Uts. case/ Qte. colis	
15354	Hoja/ leaf/ feuille	65x65x12	2400	
15355	Oval	80x80x10/2,7	2400	
15356	Mini plato/ dish/ plat	65x65x12	2400	
15357	lágrima/ tear/ larme	105x52x5/20	2400	
10763	Swing	128x65x17	600	
N465	Mini plato/ dish/ plat	90x90	1600	



Ref.	Descripción /description	mm	ml	Packs	Uds. Caja/Uts. case/ Qte. colis	
10056	Bowl komodo	120x80x45	300	6 packs x 100uts	600	
10762	Dessert Bowl "Jenny"	120x90	150	8 packs x 50 uts	400	

# Green Cocktail

Koopa Bio



Bio



Sirve tus postres y degustaciones en estos Vasitos de PLA!  
 Serve your desserts and tastings in these PLA cups!  
 Servez vos desserts et dégustations dans ces tasses en PLA!



Ref.	Descripción /description	mm	ml	Uds. Caja/Uts. case/ Qte. colis	
18348	kopa PLA	50x50x45	60	300	
18349		40x40x82	100	300	
18350		59x59x72	160	400	
18351		72x72x72	220	400	



## Cesta/ basket/ panier Bangkok



French Fries

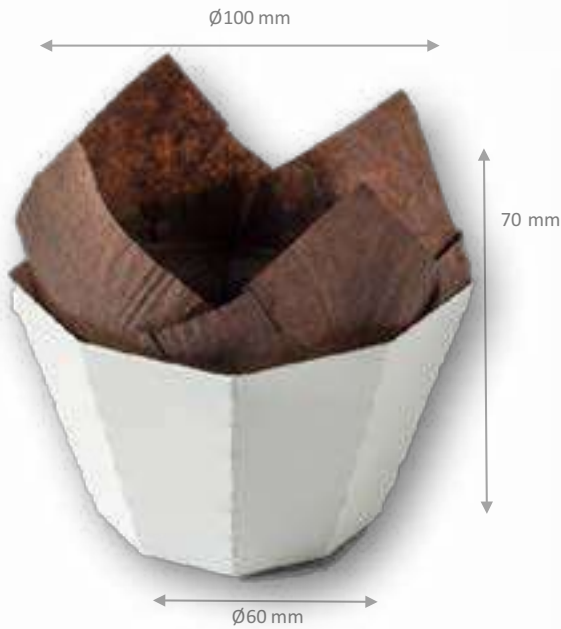
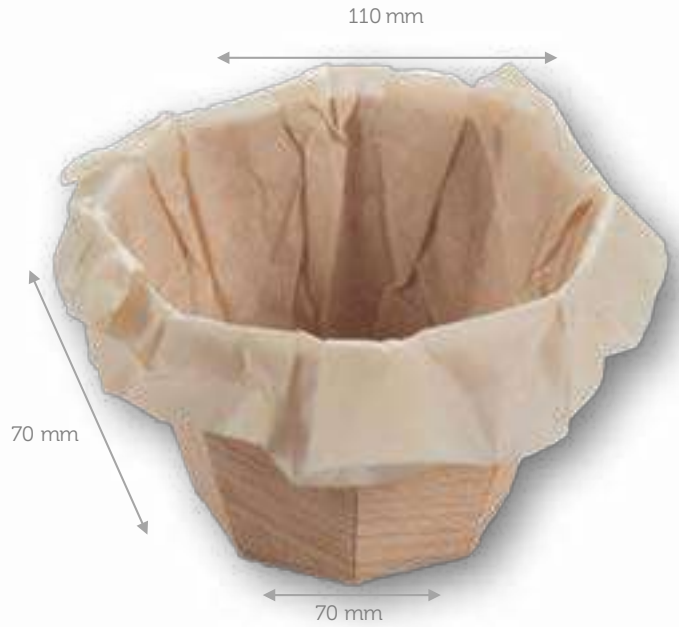

Ref.	Descripción / description	mm	Packs	Uds. Caja/Uts. case/ Qte. colis
1450	Cesta Bangkok	110/70x70	-	567
1232	French Fries	100/60x70	10 packs x 50 uts.	500

# Green Cocktail

Vasos/ Glasses/ Verres rPET



Ref.	Descripción /description	mm	ml	Packs	Uds. Caja/Uts. case/ Qte. colis	
1080	Mini pot cuajada/ Curd/ Caillé	Ø48x52	90	8 packs x 36 uts.	288	
1080/T	Tapa/ lid/ couvercle	-	-	6 packs x 288 uts.	1728	
1078	Pot cuajada/ Curd/Caillé	Ø59x74	250	8 packs x 25 uts.	200	
1078/T	Tapa/ lid/ couvercle	-	-	-	-	
1079	Pot yogur/ yoghurt/ yaourt	Ø55x70	180	12 packs x 18 uts.	216	
1082	Nido de abeja/ Honey comb/ Nid d'abeille	Ø40x46	90	8 packs x 36 uts.	288	



Plástico reciclado y reciclable  
Recycled and recyclable plastic  
Plastique recyclé et recyclable



# Green Cocktail

Latas/ Tins/ boîte de conserve

Hojalata electrolítica  
Electrolytic tinplate  
Fer blanc électrolytique



Productos frescos, cremas, salsas, conservas, tapas, fingerfood, postres...  
Fresh products, creams, sauces, preserves, tapas, desserts,....  
Produits frais, crèmes, sauces, conserves, tapas, desserts,...





Con tapa  
With lid  
Avec couvercle

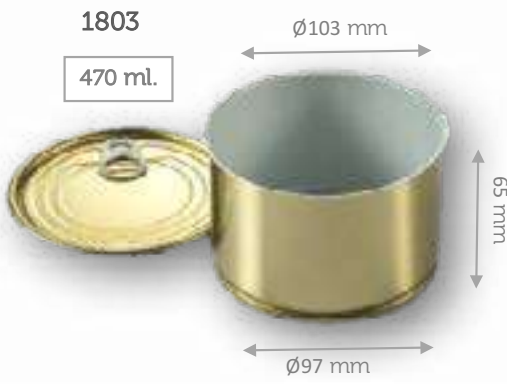

Ref.	Descripción /description	mm	ml	Packs	Uds. Caja/Uts. case/ Qte. colis
1801	Lata pequeña/ small tin/ petite boîte de conserve	Ø78/Ø72x37	120	10 packs x 20 uts	200
1802	Lata mediana/Medium tin/ moyenne boîte de conserve	Ø78/Ø74x59	240	12 packs x 10 uts	120
1803	Lata grande/ big tin/ grande boîte de conserve	Ø103/Ø97x65	470	6 packs x 12 uts	72
1800	Lata oval/ oval canned/ Boî	110x70x28	150	8 packs x 24 uts	192

# Green Cocktail

Copas/cups/ coupes Bio



Bio



Copas de PLA! Rígidas, elegantes y respetables con el medio ambiente  
 PLA cups! Rigid, elegant and environmentally friendly  
 Coupes en PLA! Rigide, élégant et respectueux de l'environnement

↖ Dos piezas  
 Two pieces  
 Deux pièces

15717

100 ml



15718

100 ml



Ref.	Descripción /description	mm	ml	Uds. Caja/ Uts. case/ Qte. colis	
15717	Copa / Cup/ Coupe champagne	Ø55x150x30	1000	135	
15718	Copa vino / wine cup/ Coupe de vin	Ø72x110x30	1000	105	



Bio

Vasos/ glasses / verres Bio



2827



Tapa válida para todas las referencias  
Lid valid for all references  
Couverture valable pour toutes les références

2825

500 ml



2824

400 ml



2823

300 ml



Ref.	Descripción /description	cm	ml	Uds. Caja/Uts. case/ Qte. colis	
2823	Vaso/ Glass/ Verre PLA	Ø9,6	300	1200	
2824		Ø9,6	400	1200	
2825		Ø9,6	500	1200	
2827	Tapa Vaso/ lid Glass/ Couvercle Verre PLA	Ø9,6		1200	

# Madera/ Wood/ Bois







# Madera/ Wood/ Bois

Molde horneable/ Baking mold/ Moule pour four Bombay



Más tamaños bajo pedido mín.  
More sizes on min. request  
Plus détails sur min. demande

Bio



Papel horneable incluido  
Baking paper included  
Papier de cuisson inclus

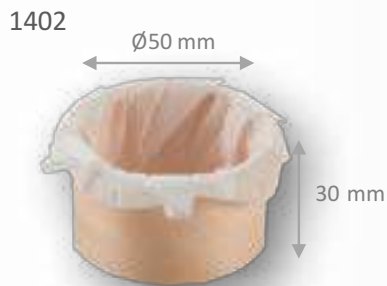



→ Algunas medidas apilables/  
Some stackable measures/  
Quelques mesures empilables /dégustations, les

↪ Ideal para quesos, platos preparados al horno, degustaciones, pasteles, panes, tapas....  
Ideal for cheeses, baked dishes, tastings, cakes, breads, tapas,....  
Idéal pour les fromages, les plats cuits au four, les dégustations, les

1437      Ø100 mm



1438      Ø 120 mm



1440      Ø140 mm



1406      Ø180 mm



Ref.	Descripción /description	mm	Uds. Caja/Uts. case/ Qte. colis	
1402	Aro de madera + papel horneable/ Wooden ring + baking paper/ Cercle en bois + cassiette	Ø50x30	850	
1442		Ø70x35	450	
1437		Ø100x40	200	
1438		Ø120x40	183	
1440		Ø140x40	125	
1406		Ø180x40	84	

# Madera/ Wood/ Bois

Molde horneable/ Baking mold/ Moule pour four Manila



Más tamaños bajo pedido mín.  
More sizes on min. request  
Plus détails sur min. demande

Bio



Idéal para lasañas y platos preparados al horno, quesos, degustaciones, pasteles, panes, tapas...

BIdeal for lasagna and baked dishes, cheeses, tastings, cakes, breads, tapas...

PIdeal pour les lasagnes et les plats cuits au four, fromages, dégustations, gâteaux, pains, tapas...



1416

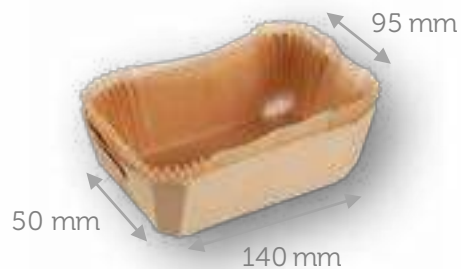

Ref.	Descripción /description	mm	Uds. Caja/Uts. case/ Qte. colis	
1414	Molde rectangular + papel horneable/ Rectangular mold + baking paper/ Moule rectangulaire+ cassette	115x60x35	160	
1416		140x95x50	700	
1490		185x115x60	364	

# Madera/ Wood/ Bois

Cosido y apilable  
Sew and stackable  
Cousú et empilables

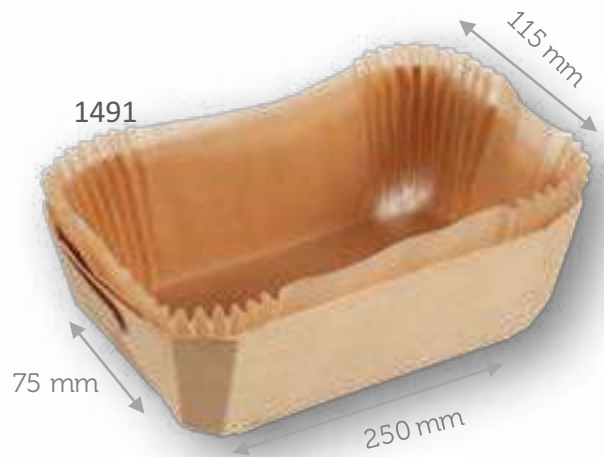
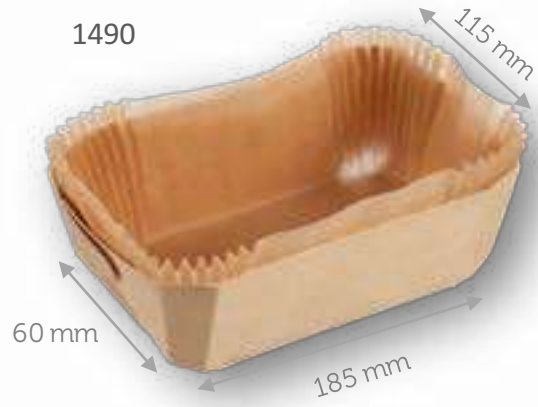

# Madera/ Wood/ Bois

## Pot camembert



Más tamaños bajo pedido mín.  
More sizes on min. request  
Plus détails sur min. demande



Min  
25000u.



220°  
40'



*ideal para quesos y mantequilla!*  
*Ideal for cheese and butter!*  
*Idéal pour les fromages et le beurre!*



Ref.	Descripción /description	mm	Uds. Caja/Uts. case/ Qte. colis	
1550	Pot Camembert	Ø75x40	390	
1551		Ø90x40	272	
1552		Ø120x60	99	
1553		Ø180x75	24	
1550/P	Papel/paper/papier Pot Camembert			
1551/P				

1550



1553



1551

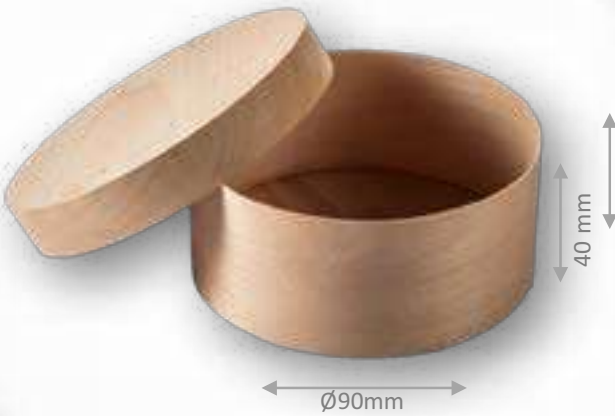

1552



Separadores y tapa con ventana bajo pedido  
Separators and cover with window upon re-  
quest Séparateurs et couvercle avec fenêtre sur commande



Más tamaños bajo pedido min.  
More sizes on min. request  
Plus details sur min. demande



Min  
25000u.



*Ofrece una presentación única con estas cestas de madera inspiradas en las tradicionales cestas para picnic. Son ideales para cualquier tipo de presentación, no solo comida.*

*Offer a unique presentation with these wooden baskets inspired by traditional picnic baskets. They are ideal for any type of presentation, not just food*

**Offrez Offrez une présentation unique avec ces paniers en bois inspirés des paniers pique-nique traditionnels. Ils sont idéaux pour tout type de présentation, pas seulement pour la nourriture**



1519



Para servir menú completo  
For the Daily meal  
Plateau Repas



Bandejas interiores pag. 12-14  
Interior trays on page 12-14  
Plateaux intérieurs à la page 12-14

Ref.	Descripción /description	mm	Uds. Caja/Uts. case/ Qte. colis	
1519	Cesta picnic 2 asas/ 2 picnic basket 2 handle/ Panier pique nique	210x180x60	52	
1470	2 poignées	310x310x100	24	
1470/T	Tapa/ lid/ couvercle			



Más tamaños bajo pedido min.  
More sizes on min. request  
Plus details sur min. demande



El envase perfecto para frutas y verduras  
Perfect packaging for vegetables and fruits  
Parfait pour les fruits et légumes



1511

1512

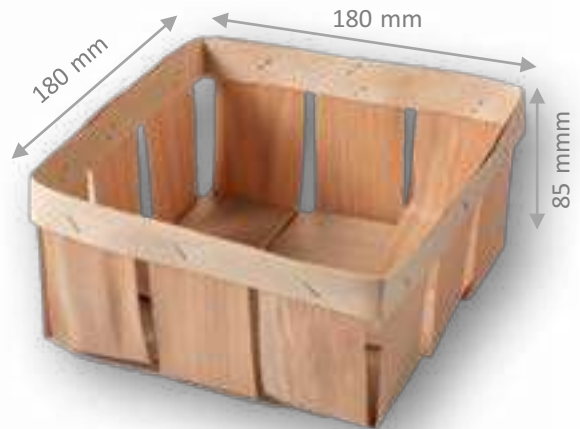
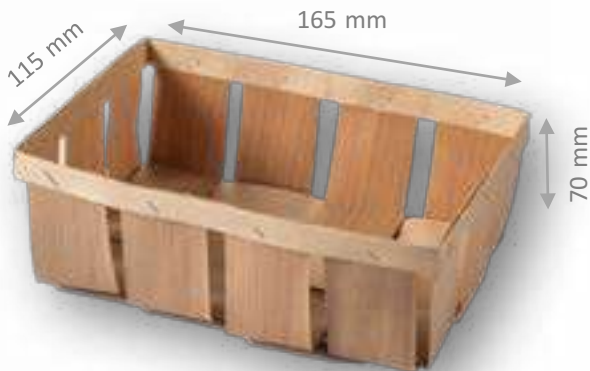



1513



1522

Posibilidad de papel  
Possibility of paper  
Possibilité de papier

**NEW**



180 mm

85 mm

55 mm

260 mm

165 mm

165 mm

Cosida  
Sew  
Cousú

Ref.	Descripción /description	mm	Uds. Caja/Uts. case/ Qte. colis	
1511		165x115x70	192	
1512	Cesta Picnic/ picnic basket/ Panier Pique-nique	180x180x85	82	
1513		260x180x85	50	
1522		165x165x55	92	

# Madera/ Wood/ Bois

## Picnic Colection

BAJO PEDIDO  
ON REQUEST  
SUR DEMANDE



Para servir menú completo  
*For the daily meal*  
Plateau repas



BAJO PEDIDO  
ON REQUEST  
SUR DEMANDE



# Bandejas/ trays / Plateaux





# Bandejas/ trays / Plateaux

Bandejas efecto pizarra/ slate effect trays/  
Plateaux effet ardoise

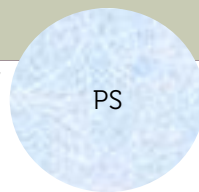

Ref.	Descripción /description	mm	Packs	Uds. Caja/Uts. case/ Qte. colis	
1063	Bandeja efecto pizarra/ slate effect trays/ Plateaux effet ardoise	275x185x10	10 packs x 5 uts.	50	
1064		317x240x10	10 packs x 5 uts.	50	
1065		370x270x10	10 packs x 5 uts.	50	
1063/T	Tapa Bandeja efecto pizarra/ Lid slate effect trays/ Couvercle plateaux effet ardoise	277x190x55	-	50	
1064/T		320x230x60	-	50	
1065/T		380x270x55	-	50	





Tamaño atlas  
Atlas size  
Talle de l'Atlas

Todas con tapa rPET  
All with rPET lid  
Tous avec couvercle rPET

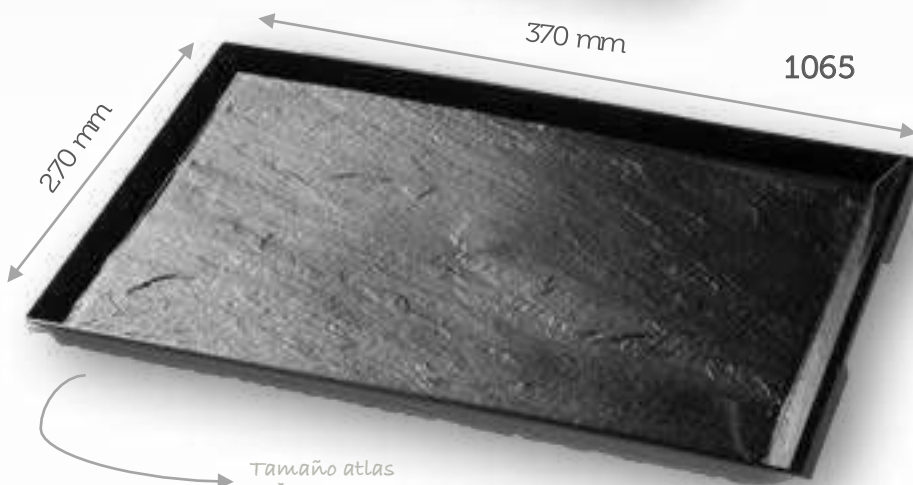
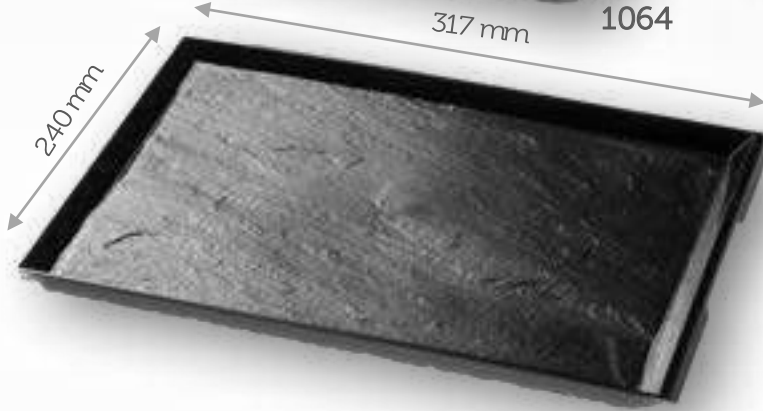
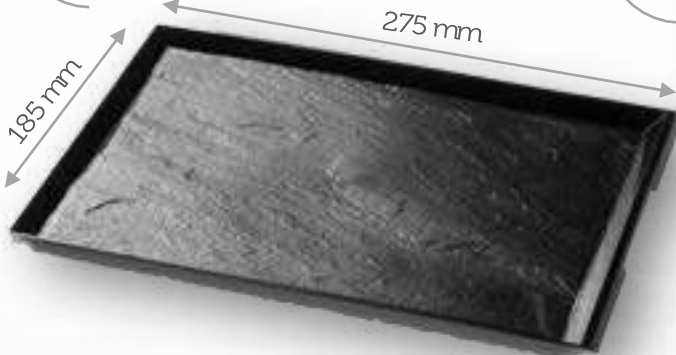

Tamaño atlas  
Atlas size  
Talle de l'Atlas

# Bandejas/ trays / Plateaux

Bandejas Arc/ Arc trays/ Plateaux Arc



1052  
1052/N

Negro y transparente  
Black and transparent  
Noir et transparent



1053  
1053/N



Tapa  
Lid  
Couvercle

Ref.	Descripción /description	mm	Packs	Uds. Caja/Uts. case/ Qte. colis
1052-1052/N	Bandeja/ Tray/ Plateaux Arc (negro y transp./ Black and transp./ Noir et transp.)	330x260	10 packs x 5 uts.	50
1053-1053/N		380x290	10 packs x 5 uts.	50
1052/T	Tapa/ Lid/ Couvercle	330x260	-	50
1053/T		380x290	-	50



Tapa  
Lid  
Couverture  
rPET



1016



1034  
1034/TV

Negro y transparente verde  
Black and green transparent  
Noir et vert transp.

Ref.	Descripción /description	mm	Packs	Uds. Caja/Uts. case/ Qte. colis	
1016	Bandeja transp./ transp. tray/ plateau transp.	370x280x18	8 packs x 6 uts.	48	
1065/T	Tapa Llid/ couvercle	-	-	50	
1034	Bandeja (negra y transp. verde)/ tray (black and green transp.)/ Plateau (noir et vert transp.)	300x230x20	10 packs x 5 uts.	50	
1034/T	Tapa Llid/ couvercle	-	-	50	

# Bandejas/ trays / Plateaux

Plateau-repas madera/ Wooden lunch tray/  
Plateu-repas en bois



REUSABLE



Plateau-Repas es un concepto de bandeja diseñada para ser transportada así como para incluir compartimentos para separar los diferentes platos que contienen el menú diario.

*Lunch-tray is a tray concept designed for transport purposes as well as to include compartments to separate the different dishes that make up the take away daily menu.*

Plateau-Repas est un concept de plateau conçu come util de trasport ainsi que la solution traiteur pour les menus a livrer/ emporter au bureau quand on a pas le temps pour manger



Bandejas interiores en pág. 12-14  
interior trays on page 12-14  
plateaux intérieurs à la page 12-14

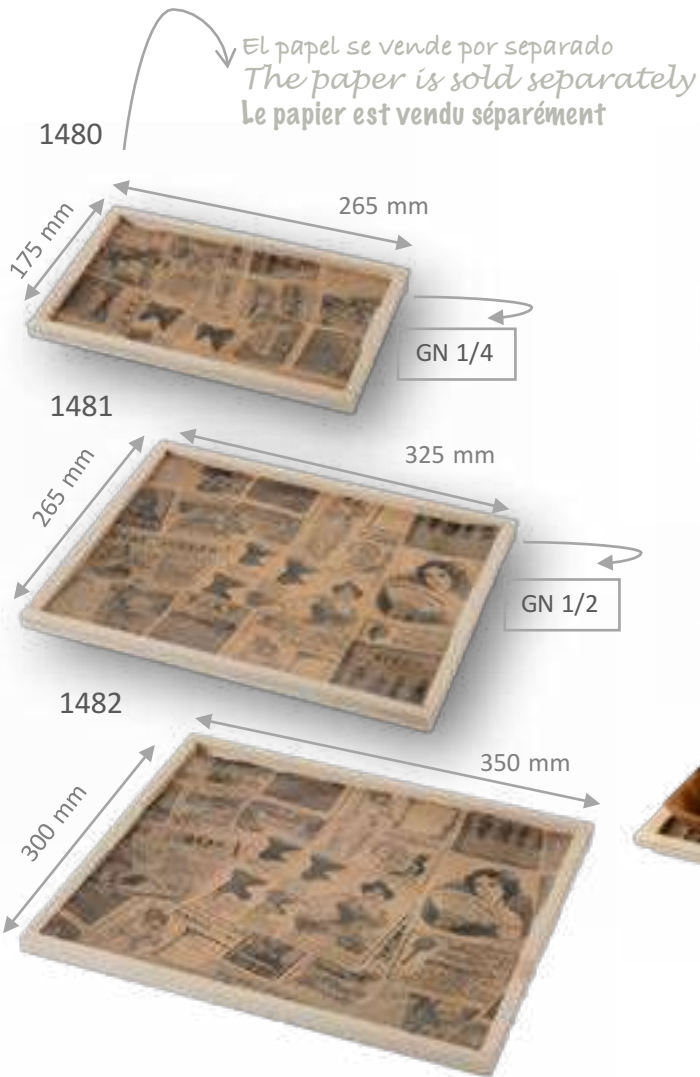

Bandejas interiores en pág. 12-14  
interior trays on page 12-14  
plateaux intérieurs à la page 12-14

Ref.	Descripción /description	mm	Packs	Uds. Caja/Uts. case/ Qte. colis	
1480	Plateau-repas/ Lunch tray	265x175x10	-	30	
1481		325x265x10	-	30	
1482		350x300x10	-	30	
1481/T	Tapa/ Lid/ Couvercle	325x265x58	-	120	
1482/T		350x300x58	-	120	
1480/P	Papel/ Paper/ Papier/ Vintage	243x152	10 packs x 500 uts.	5000	
1481/P		303x244	4 packs x 500 uts.	2000	
1482/P		328x278	4 packs x 500 uts.	2000	

# Platos/ Plates/ Assiettes





# Platos/ Plates/ Assiettes

Colección Dana/ Dana Collection



Ref.	Descripción /description	mm	Packs	Uds. Caja/Uts. case/ Qte. colis	
1300	Plato cuadrado / Square plate / Assiette carrée	110x110	20 packs x 20 uts.	400	
1301		170x170	10 packs x 20 uts.	200	
1303		250x250	20 packs x 10 uts.	200	
1307		220x220	20 packs x 10 uts.	200	



1301



1303



1300



1301



1307



1303



# Platos/ Plates/ Assiettes

Colección Dana/ Dana Collection



Bio



Gama Económica  
Economic range  
Gamme économique

1306

400 ml



40 mm

178 mm

Ref.	Descripción /description	ml	mm	Packs	Uds. Caja/Uts. case/ Qte. colis
1306	Bowl Dana	400	ø178x40	12 packs x 50 uts.	600

Bio

\$



Gama Económica  
Economic range  
Gamme économique

1304



Ø180

1305



Ø230



Ref.	Descripción /description	mm	Packs	Uds. Caja/Uts. case/ Qte. colis	
1304	Plato redondo/ Round plate/ Assiette ronde Dana	Ø180x20	16 packs x 50 uts.	800	
1305		Ø230x20	16 packs x 50 uts.	800	

# Platos/ Plates/ Assiettes

Colección komodo/ Komodo Collection



Bio



N468



ZE13099

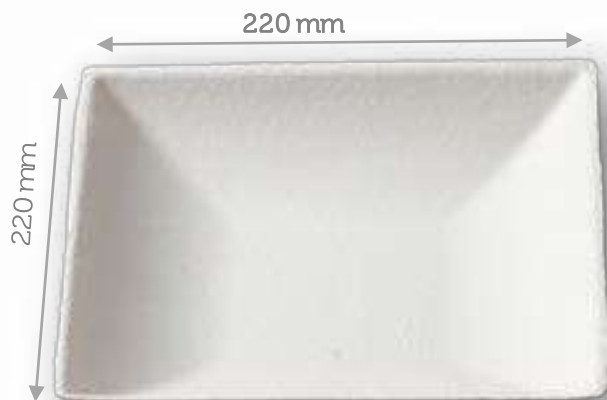

Ref.	Descripción /description	mm	Packs	Uds. Caja/Uts. case/ Qte. colis	
N468	Plato cuadrado / Square plate / Assiette carrée	180x180	-	400	
ZE13099		220x220	10 packs x 50 uts	500	
N466	Plato rectangular / Rectangular plate / Assiette rectangulaire	180x90	16 packs x 50 uts	800	
N467		270x90	8 packs x 50 uts	400	



N466



N467



# Platos/ Plates/ Assiettes

Platos hoja de palma/ Palm leaf plates/  
Assiettes feuille de palmier



1010249



1010241  
1010220



1010219



1010218



1010221



1010243



Ref.	Descripción /description	mm	Packs	Uds. Caja/Uts. case/ Qte. colis	
1010249	Plato hondo	160x160	4 packs x 25 uts	100	
1010241	Plato cuadrado	200x200	4 packs x 25 uts	100	
1010220	Plato cuadrado	250x250	4 packs x 25 uts	100	
1010219	Plato rectangular	250x160	4 packs x 25 uts	100	
1010218	Bandeja ovalada	350x240	4 packs x 25 uts	100	
1010221	Bol	Ø130	4 packs x 25 uts	100	
1010243	Bol oval	Ø80	25 packs x 30 uts.	750	

# Platos/ Plates/ Assiettes

Platos salvado de trigo/ wheat bran plates/  
Assiettes son de blé

salvado de trigo  
Wheat bran  
Son de blé

Bio



1700

Ø240 mm



1701

Ø200 mm



1702

Ø200 mm



1703

Ø240 mm



Ref.	Descripción /description	mm	Packs	Uds. Caja/Uts. case/ Qte. colis	
1700	Plato/ Plate/ Assiette Biotrem	Ø240	2 packs x 50 uts	100	
1701		Ø200	2 packs x 50 uts	100	
1702		Ø200	4 packs x 25 uts	100	
1703	Bowl Biotrem	24x16x35	4 packs x 25 uts	100	

# Cubiertos & Accesorios/ cutlery & Accessories/ Couverts & Accessoires







# Cubiertos/ Cutlery/ Couverts

Cubiertos/ Cutlery/ Couverts PLA



Bio

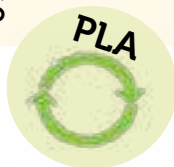

En blanco y en negro  
In black and white  
Noir et blanc



**NEW**

Ref.	Descripción /description	mm	Uds. Caja/Uts. case/ Qte. colis	
ZE13028	Tenedor/ Fork/ fourchette PLA	17 X 2,6 X 0,3	1000	
ZE13029	Cuchillo/ knife/ Couteau PLA	17 X 2 X 0,3	1000	
ZE13030	Cuchara/ Spoon/ Couteau PLA	17 X 3,5 X 0,3	1000	
ZE13031	Cucharita/ Mini spoon/ Mini couteau PLA	13 X 3 X 0,5	1000	
ZE13033	Set tenedor+cuchillo+servilleta+cucharita/Set fork + knife + napkin + teaspoon/Set fourchette + couteau + serviette + cuillère à café		250	
1010504 (blanco/white/blanc) 1010538 (negra/ black/ noir)	Tenedor/ Fork/ fourchette PLA	16,8	1500	
1010506 (blanco/white/blanc) 1010540 (negra/ black/ noir)	Cuchillo/ knife/ Couteau PLA	16,8	1500	
1010505 (blanco/white/blanc) 1010541 (negra/ black/ noir)	Cuchara/ Spoon/ Couteau PLA	16,8	1500	

# Cubiertos/ Cutlery/ Couverts

Cubiertos/ Cutlery/ Couverts Madera/ wood/ bois



**NEW**



Tamaño Mini  
Mini size  
Mini taille



**NEW**

Ref.	Descripción /description	mm	Packs	Uds. Caja/Uts. case/ Qte. colis	
ZE19348	Mini tenedor negro PLA/ Mini black fork PLA/ Mini fourchette noir en PLA	100	10 packs x 100 uts	1000	
ZE19349	Mini cuchara negro PLA/ Mini black spoon PLA/ Mini couteau noir en PLA	100	10 packs x 100 uts	1000	
1366	Tenedor Madera/ Wooden Fork/ fourchette en bois	160x24	20 packs x 100 uts	2000	
1367	Cuchillo Madera/Wooden knife/ Couteau en bois	160x20	20 packs x 100 uts	2000	
1368	Cuchara Madera/ Wooden Spoon/ Couteau en bois	160x32	20 packs x 100 uts	2000	

# Cubiertos/ Cutlery/ Couverts

Cubiertos/ Cutlery/ Couverts Bambú



Textura suave y agradable  
Soft and pleasant texture  
Texture douce et agréable



Ref.	Descripción /description	mm	Packs	Uds. Caja/Uts. case/ Qte. colis	
1360	Tenedor/ Fork/ fourchette Bambú	170x24	20 packs x 100 uts	2000	
1361	Cuchillo/ knife/ Couteau Bambú	160x24	20 packs x 100 uts	2000	
1362	Cuchara/ Spoon/ Couteau Bambú	170x32	20 packs x 100 uts	2000	
1363	Mini Tenedor/ Fork/ fourchette Bambú	120x24	20 packs x 100 uts	2000	
1364	Mini Cuchara/ Spoon/ Couteau Bambú	105x24	20 packs x 100 uts	2000	

# Cubiertos/ Cutlery/ Couverts

Brochetas/ Skewer/ Piques



Bio

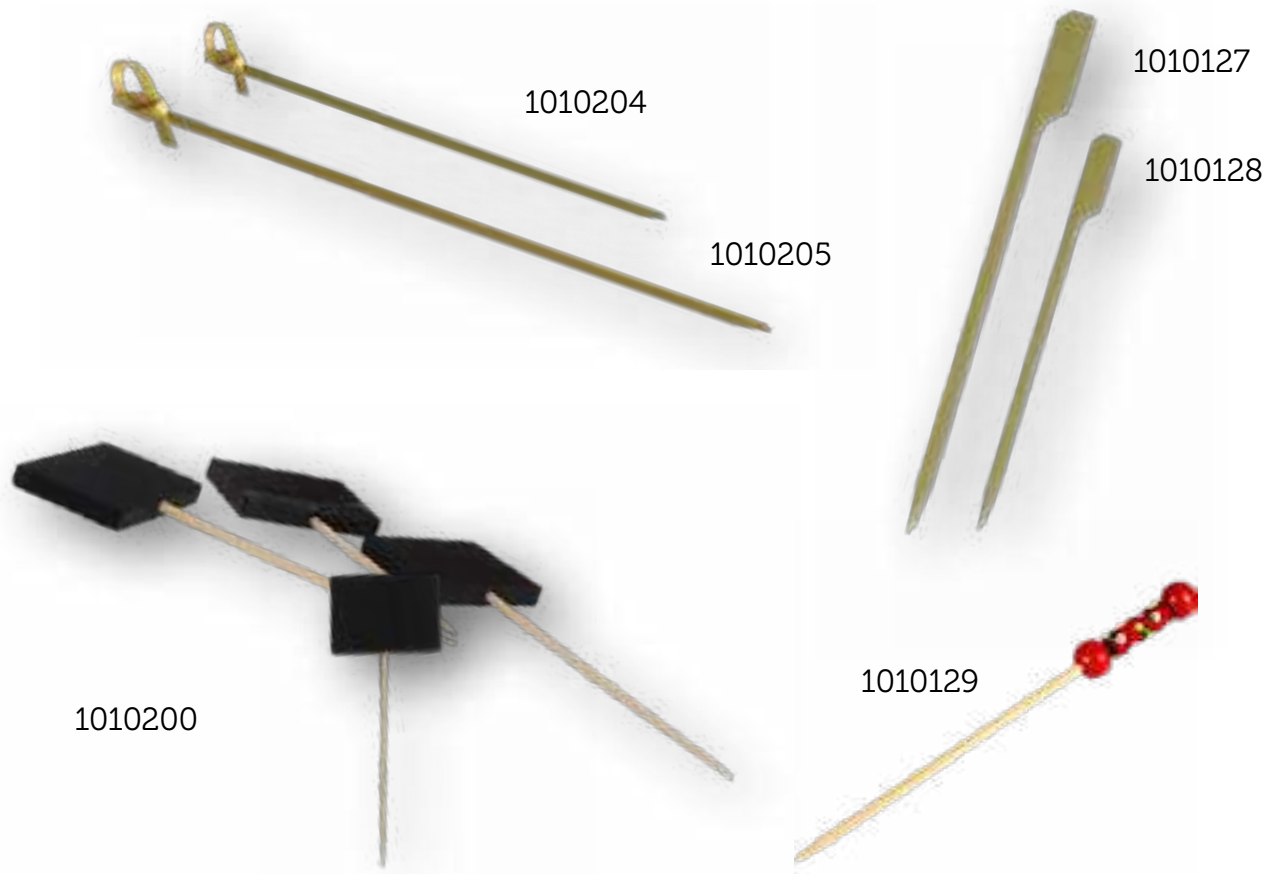

Ref.	Descripción /description	mm	Packs	Uds. Caja/Uts. case/ Qte. colis	
1010127	Pincho bambú golf/ Bamboo golf skewer/ Brochette de golf en bambou	105	25 packs x 200 uts	5000	
1010128		150	25 packs x 200 uts	5000	
1010129	brocheta bambú fruit picks / skewer bamboo fruit picks/ brochette bambou fruits picks (rojo/red/rouge & amarillo/yellow/jeune)	120	25 packs x 200 uts	5000	
1010204	Brocheta lazo bambú/ Bamboo bow skewer/Brochette d'arc en bambou	90	25 packs x 200 uts	5000	
1010205		150	25 packs x 200 uts	5000	
1010200	Brocheta pizarra/ Slate Skewer/ Brochette ardoise	90	25 packs x 100 uts	2500	

# Cubiertos/ Cutlery/ Couverts

Pajitas negras de papel/ Black paper straws/  
Pailles en papier noir



Bio

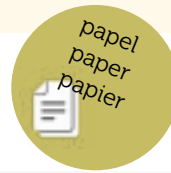

3 modelos: standard, cocktail y smoothie!  
3 models: standard, cocktail and smoothie  
3 modèles: standard, cocktail et smoothie!



Pajitas verdes de PLA/ Green PLA straws/  
Pailles en PLA vert



Funda individual  
Individual case  
Cas individuel

Ref.	Descripción /description	cm	Packs	Uds. Caja/Uts. case/ Qte. colis	
1272	Pajita papel standard/ standard paper straw/ paille de papier standard	20 x ø0,6	40 packs x 250 uts	10000	
1273	Pajita papel cocktail/ cocktail paper straw/ paille de papier cocktail	14 x ø0,6	40 packs x 250 uts	10000	
1274	Pajita papel smoothie/ smoothie paper straw/ paille de papier smoothie	20 x ø0,8	20 packs x 250 uts	5000	
1270	Pajitas PLA/ PLA straw/ paille en PLA	23 x ø0,6	8 packs x 500 uts	4000	

# Cubiertos/ Cutlery/ Couverts

Servilletas papel reciclado/ recycled paper napkins/ serviettes en papier recyclé

**NEW**

papel  
paper  
papier

Bio



510035



510036



510037



Ref.	Descripción /description	cm	Packs	Uds. Caja/Uts. case/ Qte. colis	
510035	servilleta papel reciclado/ recycled paper napkin/ serviette en papier recyclé	20x20	30 packs x 100 uts	3000	
510036		40x40	24 packs x 50 uts	1200	
510037	servilleta papel cocktail negra	20x20	30 packs x 100 uts	3000	

# Cocktail







# Cocktail

## Koopa



Con tapa  
With lid  
Avec couvercle

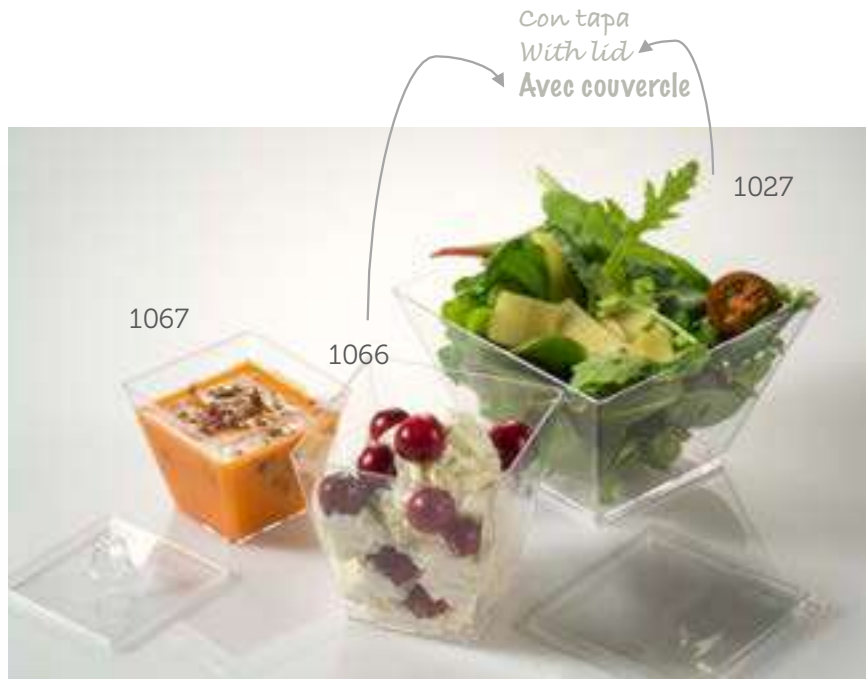

Ref.	Descripción /description	mm	ml	Packs	Uds. Caja/Uts. case/ Qte. colis
1067	Mini koopa	50x50x45	70	20 packs x 50 uts.	1000
1066	koopa pequeña/small/petite + tapa/ lid/couvercle incl.	59x59x52	120	20 packs x 24 uts.	480
1027	koopa mediana/ Medium/ Moyenne	67x67x67	200	24 packs x 30 uts.	720
1027/t	Tapa/ lid/ couvercle koopa mediana/ Medium/ Moyenne	73x73x11			2500
1068	koopa Square	88x88x60	530	18 packs x 10 uts	180
1068/t	Tapa/ lid/ couvercle koopa square	93x93x6			540



Apilable para las presentaciones más chic!  
Stackable for the most chic presentations!  
Empilable pour vos événements les plus chic!



Ref.	Descripción /description	mm	ml	Uds. Caja/Uts. case/ Qte. colis	
1090	Cajita cuadrada/ Square/ carré	75x75x58	200	315	
1093	Burbuja/ Bubble/ Bulle	Ø120	500	155	
f587-06	Pot rosca/ Thread/ Vissé	Ø 68x97	300	250	
f581-06	Tapa/ lid/ couvercle	-	-	250	

# Cocktail

## Finger Food



1025-



1025/N



1098

1 ml



Ref.	Descripción /description	mm	Packs	Uds. Caja/Uts. case/ Qte. colis	
1020 & 1020/N	Cuchara/ spoon/ Cuillère Rita (negro/black/noire & transp.)	130x39x35	24 packs x 60 uts.	1440	
1025 & 1025/N	Lágrima degustación/ tasting tear spoon/ larme degustation (negro/black/noire & transp.)	101x50x27	20 packs x 50 uts.	1000	
1098	Pipeta/ Pipette	10x87 (1ml.)	-	750	
1014	Mini tenedor/ fork/ fourchette	97x21	40 packs x 250 uts.	10000	
1015	Mini Cuchara/ spoon/ Cuillère	96x21	40 packs x 250 uts.	10000	

PS



1040



1019

90 ml



1023

90 ml



Ref.	Descripción /description	mm	Packs	Uds. Caja/Uts. case/ Qte. colis
1040	Plato oval/ oval dish/ assiette ovale	85x70x18	14 packs x 60 uts.	840
1019	Plato/ plate/ assiette mini beat	75x75x17	24 packs x60 uts.	1440
1023	Mini cazuela/ casserole/ cocotte	70x62x30	16 packs s 30 uts.	480

# Cocktail

## Vasitos/ mini cups / verrines



1022

80 ml.



1094

70 ml.



1018

70 ml.



1077

50 ml



1076

25 ml



1070

85 ml



1071

170 ml

Ref.	Descripción /description	mm	ml	Uds. Caja/Uts. case/ Qte. colis	
1070	The kilix peq./ Small/ Petite	Ø72x44	85	400	
1071	The kilix grande/ big/ grande	Ø72x78	170	200	
1072	Kit tapa/ lid/ couvercle The kilix (tapa+clip+goma) (lid+clip+ruber) (couvercle+clip+gomme)			400	
1022	Vaso truncado/ Truncated glass/ Verre tronqué	Ø47/Ø37x83	80	720 (24 packs x30 uts)	
1018	Mini vaso/ glass/ verre Pixel	Ø50/Ø30x60	70	300 (10 packsx30 uts)	
1094	Mini vaso/ glass/ verre Zurito	Ø57/Ø51x33	70	500	
1076	Vasito/ mini glass/ mini verre Cubilete	Ø37/Ø23x33	25	1000	
1077	Vasito cuadrado/ mini square glass/ mini verre carré Cubilete	48/30x36	50	800	

Copas/ cups/ coupes



Copa/ Cup/ Coupe Gyn

1056

600 ml.



*ideal para terrazas!*  
*ideal for terraces!*  
*Idéal pour les terrasses!*



Copa/ Cup/ Coupe champagne

1045

180 ml.



1024

80 ml.

Ref.	Descripción /description	mm	ml	Packs	Uds. Caja/Uts. case/ Qte. colis
1056	Copa/ Cup/ Coupe Gyn	Ø105/Ø95x185	600	-	8
1045	Copa/ Cup/ Coupe Champagne	Ø55x190	180	24 packs x 6 uts.	144
1024	Copa/ Cup/ Coupe Cocktail	Ø62x126	80	18 packs x 12 uts.	216

# Cocktail



Copa/ cup/ coupe Elena

1074

300 ml.

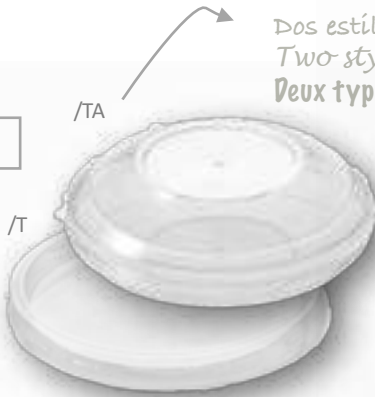

Dos estilos de tapa  
Two styles of lid  
Deux types de couvercle



Copa/ cup/ coupe Joana

1075

200 ml.

Apilable y con Tapa  
Stackable and with lid  
Empilable et avec Couvercle

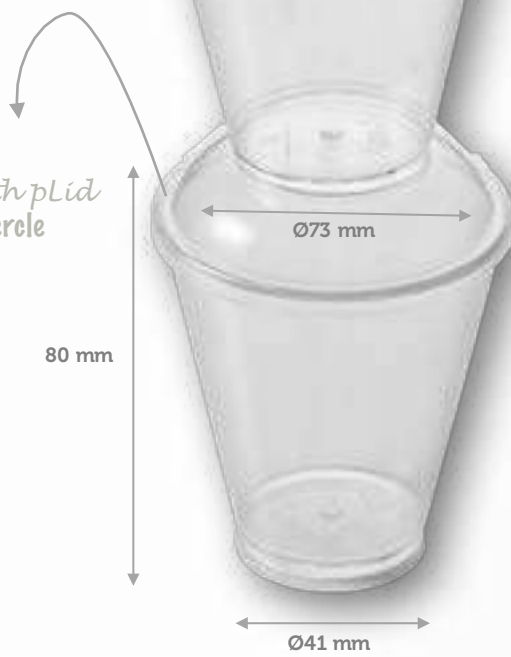

Ref.	Descripción /description	mm	ml	Packs	Uds. Caja/Uts. case/ Qte. colis
1074	Copa/ cup/ coupe Elena	Ø100/Ø57x80	300	23 packs x 12 uts.	276
1074/T	Tapa/lid/ couvercle	Ø100x10	-	-	276
1074/TA	Tapa alta/ high lid/ couvercle haut	Ø100x20	-	-	276
1075	Vaso-Copa/ Cup-glass/ Verre-coupe Joana	Ø73/Ø41x80	200	10 packs x 30 uts.	300
1075/T	Tapa/lid/ couvercle	-	-	-	300



PS



VS500PS

500 ml.

Dos tamaños. El grande con tapa.  
Two sizes. Bi size with lid.  
Deux tailles le grand avec



1060

70 ml.

1061

160 ml.



1058

190 ml.

Para chupitos, muestreo, postres y licor  
Shots, sampling, Liquor and desserts  
Shots, échantillons, desserts et spiritueux

Ref.	Descripción /description	mm	ml	Packs	Uds. Caja/Uts. case/ Qte. colis
VS500PS	Vaso/ Glass/ Verre sidra	Ø92x160	500	-	500
1058	Copa con pie/ Cup with food/ Coupe avec pied	Ø58x103	190	20 packs x 10 uts	200
1060	Vaso arrugado pequeño/ small crumpled glass/ verre froissé petite (negro/black/noir, blanco/ white/blanc, transp.)	Ø60x50	60-80	36 pack x 10 uts	360
1061	Vaso arrugado grande/ big crumpled glass/ verre froissé grande (transp.)	Ø75x65	140-180	10 packs x 25 uts	250
1021/T	Tapa vaso arrugado grande/ Lid big crumpled glass/ Couvercle verre froissé grande	Ø75x57	-	-	600

# Cocktail

Píxel Collection



PS

Con tapa  
With lid  
Avec couvercle



Ref.	Descripción /description	mm	ml	Packs	Uds. Caja/Uts. case/ Qte. colis	
1018	Mini vaso/ glass/ verre Pixel	Ø50/ Ø33x60	70	10 packs x 30 uts	300	
1047	Vaso/ glass/ verre Mediano/ medium/ Moyenne Pixel	Ø70/ Ø40x80	160	10 packs x 30 uts	300	
1048	Vaso/ glass/ verre Grande/ big / grande Pixel	Ø80/ Ø50x100	300	10 packs x 30 uts	300	
1095/T	Tapa vaso pixel Grande/ Lid big pixel glass/ couvercle verre pixel grande	Ø85x15	-	.	600	

PS

REUSABLE



Ref.	Descripción /description	mm	ml	Packs	Uds. Caja/Uts. case/ Qte. colis	
1094	Mini vaso zurito/ Mini Zurito glass/ Mini verre Zurito	Ø57/Ø51x33	70	-	500	
1021	Vaso Zurito Mediano/ Medium/ moyenne	Ø75/Ø66x55	180	10 packs x 30 uts	300	
1021/T	Tapa vaso Zurito / Lid zurito glass/ couvercle verre zurito	Ø75x57	-	-	600	
1095	Vaso zurito grande/ big/ grande	Ø80/Ø70x60	250	10 packs x 30 uts	300	
1095/T	Tapa vaso Zurito Grande/ Lid big zurito glass/ couvercle verre zurito grande	Ø85x15	-	-	600	
2080	Vaso Zurito Grande/ big/ grande	Ø80/Ø65x76	300	-	315	



	MICRO	HORNO/ OVEN/ FOUR	CONGELABLE (-18) FREEZABLE (-18)/ CONGÉLATION (-18)	CONGELABLE (-36)/ FREEZABLE (-36)/ CONGÉLATION (-36)	BIODEGRADABLE/ BIODÉGRADABLE
PS			✓		
PP	✓		✓		
PET			✓		
KRAFT	✓		✓		
PULPA CAÑA DE AZÚCAR / SUGAR CANE PULP/ PULPE DE CANNE À SUCRE	✓	✓	✓	✓	✓
MADERA / WOOD/BOIS	✓	✓	✓		✓
CRISTAL / CRYSTAL/ VERRE	✓		✓		
PAPEL SULFURIZADO / GREASEPROOF PAPER/ PAPIER SULFURISÉ		✓	✓	✓	
SALVADO DE TRIGO / WHEAT BRAN/ SON DE BLÉ	✓		✓		✓
TRITÁN/ TRITAN	✓		✓		
HOJA DE PALMA/ PALM LEAF/ FUILLE DE PALMIER	✓		✓		✓